

Operation instructions • english  
Gebrauchsanweisung • deutsch  
Gebruiksaanwijzing • nederlands  
Manuel d'utilisation • français

1922020E

0531

# KEMPOWELD

4200

4200W

5500W



## CONTENTS

<b>1.</b>	<b>PREFACE .....</b>	<b>3</b>
1.1.	Introduction .....	3
1.2.	Product introduction .....	3
1.3.	Operation safety.....	4
1.4.	Kempoweld panels.....	5
1.4.1.	Operation control and connectors.....	5
1.4.2.	Parts of cooling unit Kempoweld 4200W and 5500W.....	5
1.4.3.	Rear plate of Kempoweld 4200, 4200W and 5500W.....	5
1.5.	Wire feeder panels.....	6
1.5.1.	Front panel.....	6
1.5.2.	Accessories.....	6
1.5.3.	Cooling unit connections.....	6
1.5.4.	Rear panel.....	6
1.5.5.	Inside wire feeder unit.....	6
1.6.	Units and cables .....	7
<b>2.</b>	<b>INSTALLATION .....</b>	<b>8</b>
2.1.	Transport and lifting of the machine.....	8
2.2.	Siting the machine .....	8
2.3.	Connection to the mains supply.....	8
2.4.	Welding and return current cables .....	8
2.5.	Operation and use of controls.....	9
2.5.1.	Main switch (S1).....	9
2.5.2.	Adjustment of welding voltage .....	9
2.5.3.	Pilot lamps.....	9
2.5.4.	Control fuse (F1) .....	9
2.5.5.	Adjustment for arc roughness .....	9
2.5.6.	Operation of cooling fan .....	10
2.5.7.	Accessory drawer.....	10
2.5.8.	Adjustment for wire feed .....	10
2.6.	Volt / ampere metering unit MSD-1 .....	10
2.7.	Cooling unit.....	10
2.7.1.	Installation of cooling.....	10
2.7.2.	Operation switches.....	11
<b>3.</b>	<b>OPERATION DISTURBANCES .....</b>	<b>11</b>
<b>4.</b>	<b>MAINTENANCE.....</b>	<b>12</b>
4.1.	Disposal of the machine.....	13
<b>5.</b>	<b>TECHNICAL DATA .....</b>	<b>13</b>
<b>6.</b>	<b>ORDERING NUMBERS.....</b>	<b>14</b>
<b>7.</b>	<b>TERMS OF GUARANTEE.....</b>	<b>15</b>

---

# 1. PREFACE

## 1.1. INTRODUCTION

Congratulations on having purchased this product. Properly installed Kemppi products should prove to be productive machines requiring maintenance at only regular intervals. This manual is arranged to give you a good understanding of the equipment and its safe operation. It also contains maintenance information and technical specifications. Read this manual from front to back before installing, operating or maintaining the equipment for the first time. For further information on Kemppi products please contact us or your nearest Kemppi distributor. The specifications and designs presented in this manual are subject to change without prior notice.

In this document, for danger to life or injury the following symbol is used: 

Read the warning texts carefully and follow the instructions. Please also study the Operation safety instructions and respect them when installing, operating and servicing the machine.

## 1.2. PRODUCT INTRODUCTION

The power sources Kempoweld 4200 and 4200W with wire feeder WIRE 400 make together 400 A MIG welding equipment, which is suitable for heavy industrial use. Kempoweld 5500W and wire feeder WIRE 550 make respectively 550 A MIG welding equipment. To the product range belongs also the power source Kempoweld 3200.

### **Power source**

Supply voltage of the Kempoweld 4200 is either 3~ 230 V or 3~ 400 V; of these both power sources exist also types Kempoweld 4200W, which are equipped with inbuilt cooling unit. Kempoweld 5500W is a compact water cooled equipment with 3~ 400 V supply voltage. Voltage of power source is adjusted with turn type switches. The Volt/Ampere metering unit MSD-1 displays voltage or welding current.

### **Wire feeder unit**

The wire feeder units WIRE 400 and WIRE 550 are 4-roll driven units, which are suitable for air- or liquid-cooled guns. The units may be turnable above the power source or they may be locked at their place. You can use the wire feeder units equipped also with interconnection cable and push-pull gun. KMW timer controls continuous, spot and cycle-arc welding. KMW sync is needed for connection and use of push-pull guns.

## 1.3. OPERATION SAFETY

### **Never watch the arc without a face shield designed for arc welding!**

- The arc damages unprotected eyes!
- The arc burns unprotected skin!

### **Be careful for reflecting radiation of arc!**

### **Protect yourself and the surroundings against the arc and hot spray!**

### **Remember general fire safety!**

- Pay attention to the fire safety regulations. Welding is always classified as a fire risk operation.
- Welding where there is flammable or explosive material is strictly forbidden.
- If it is essential to weld in such an area remove inflammable material from the immediate vicinity of the welding site.
- Fire extinguishers must always be on site where welding is taking place.
- Note! Spars may cause fire many hours after completion of welding.

### **Watch out for the mains voltage!**

- Take care of the cables - the connection cable must not be compressed, touch sharp edges or hot work pieces.
- Faulty cables are always a fire risk and highly dangerous.
- Do not locate the welding machine on wet surfaces.
- Do not take the welding machine inside the work piece (i.e. in containers, cars etc.)

### **Ensure that neither you nor gas bottles or electrical equipment are in contact with live wires or connections!**

- Do not use faulty welding cables.
- Isolate yourself by using dry and not worn out protective clothes.
- Do not weld on wet ground.
- Do not place MIG gun or the welding cables on the power source or other electrical equipment.
- Don't press on MIG gun switch, if the gun is not directed towards work piece.

### **Watch out for the welding fumes!**

- Ensure that there is sufficient ventilation.
- Follow special safety precautions when you weld metals which contain lead, cadmium, zinc, mercury or beryllium.

### **Note the danger caused by special welding jobs!**

- Watch out for the fire and explosion danger when welding container type work pieces.



**This equipment's electromagnetic compatibility (EMC) is designed for use in an industrial environment. Class A equipment is not intended for use in residential location where the electrical power is provided by the public low-voltage supply system.**

## 1.4. KEMPOWELD PANELS

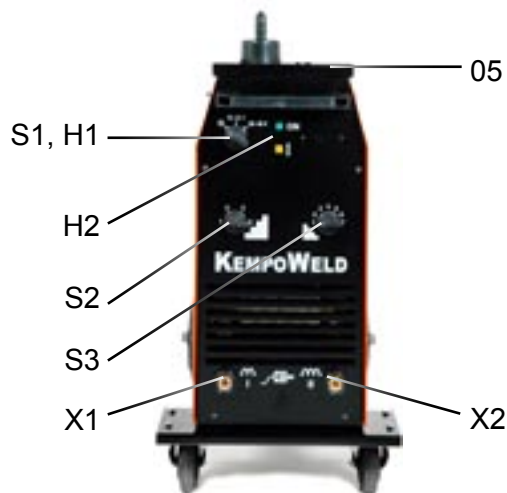

### 1.4.1. Operation control and connectors

S1	Main switch (voltage range)
S2	Voltage selecting switch (coarse grading)
S3	Voltage selecting switch (fine grading)
H1	Pilot lamp for main switch
H2	Pilot lamp for overheating (power source)
X1	Return current connector (coarser arc)
X2	Return current connector (softer arc)
05	Accessory drawer
MSD-1	V/A metering unit (accessory for 4200 and 4200W)
MSD-1	V/A metering unit (included in delivery of 5500W)



### 1.4.2. Parts of cooling unit Kempoweld 4200W and 5500W

S4	Main switch of cooling unit
Sw1	Selecting switch for gun's cooling mode
Sw2	Water cooling test switch
Hw4	Pilot lamp for overheating
Hw3	Pilot lamp for lacking water pressure
F2	Fuse for cooling unit (2 A delayed / 4200W)
F2	Fuse for cooling unit (4 A delayed / 5500W)
02	Water circulation return connector
03	Water circulation output connector
04	Filler hole for water tank

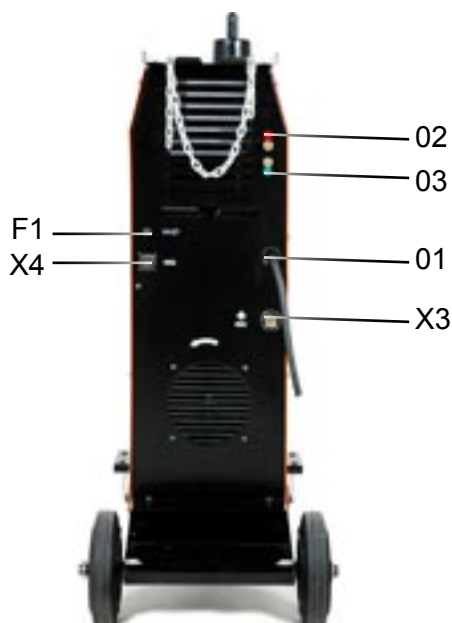

### 1.4.3. Rear plate of Kempoweld 4200, 4200W and 5500W

01	Inlet of mains cable
F1	Fuse of auxiliary transformer (8 A delayed)
X3	Welding current connector for wire feeder unit (+ pole)
X4	Control connector for wire feeder unit

## 1.5. WIRE FEEDER PANELS

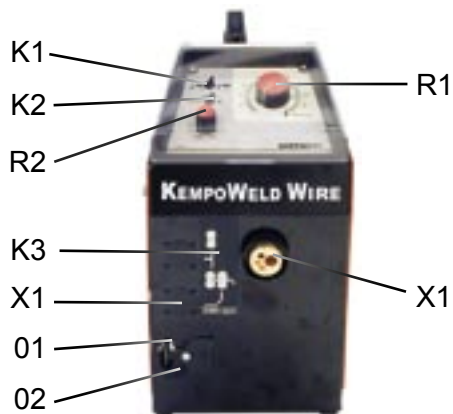

### 1.5.1. Front panel

- R1 Adjustment for wire feed
- X1 Welding gun connector (EURO)
- K1 Trigger function mode (continuous/hold)
- K2 Welding mode selection (continuous/spot/cycle arc)
- R2 Adjustment for welding mode timing (spot or cycle time)

### 1.5.2. Accessories

#### KMW sync (Accessory)

- K3 Wire feed adjustment selection (panel or push-pull gun)
- X1 Control connector for push-pull gun

### 1.5.3. Cooling unit connections

- 01 Return water connector for gun
- 02 Feed water connector for gun
- 04 Inlet of water hoses

### 1.5.4. Rear panel

- 03 Shielding gas connector
- X2 Control cable connector (Kempoweld or interconnection cable)
- X3 Welding current connection (Kempoweld or interconnection cable)

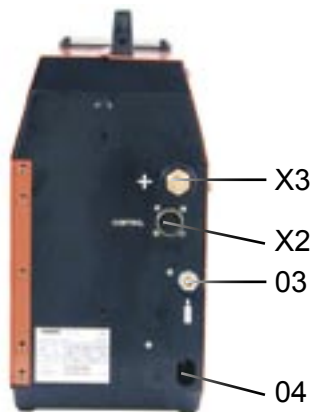

### 1.5.5. Inside wire feeder unit

- K4 Wire inch switch (wire feed into gun)
- R3 Burn back time adjustment (according to filler material and wire feed)
- 04 Locking device for wire reel
- 05 Box door latch
- 06 Box door lock
- 07 Wire feed mechanism

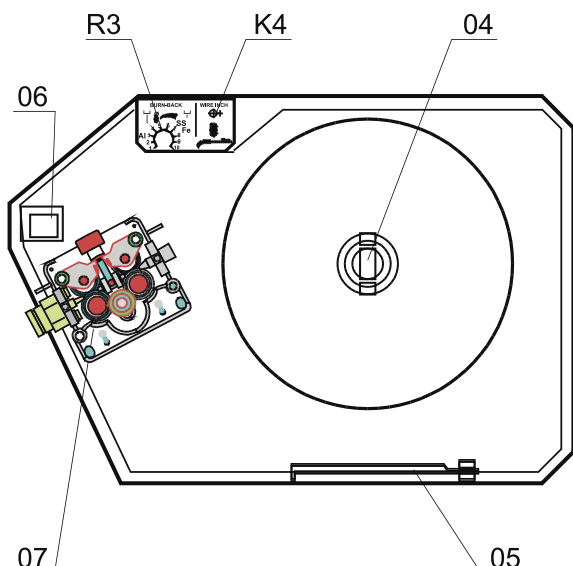

## 1.6. UNITS AND CABLES

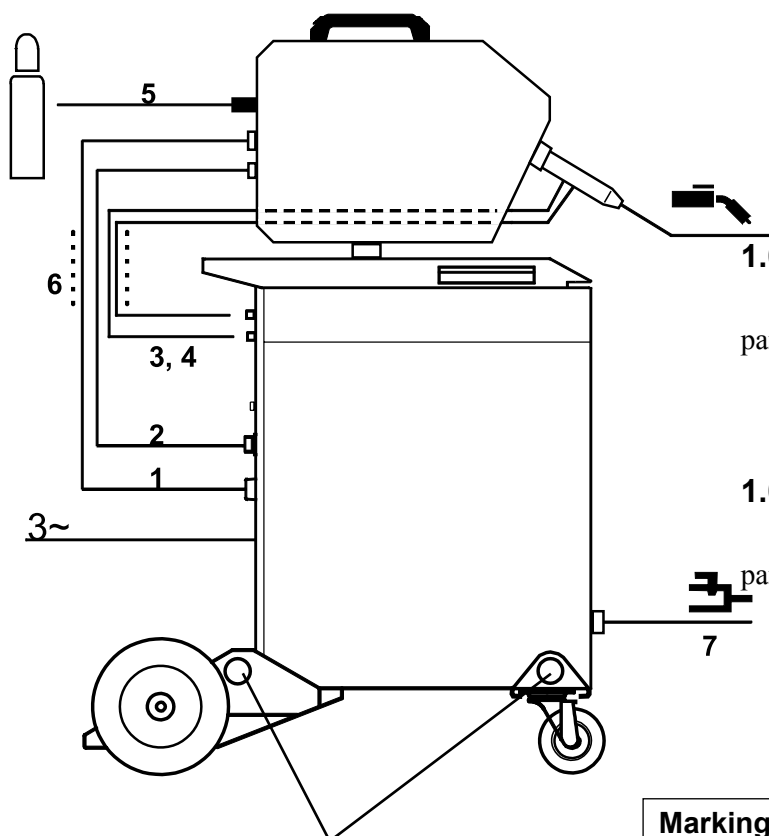

### 1.6.1. Air-cooled interconnection cables:

part	1	welding current cable
	2	control cable
	5	shielding gas hose
	6	protective hose

### 1.6.2. Liquid-cooled interconnection cables:

part	1	welding current cable
	2	control cable
	3	water hose, blue marking
	4	water hose, red marking
	5	shielding gas hose
	6	protective hose

 Lift points, lifting allowed without gas bottle!  
(see Operation and use of power source)

### Marking of interconnection cable item:

Example: KW 50-5-WH

KW = identification letters

50 = welding cable cross-section mm<sup>2</sup>

5 = nominal reach in meters

W = liquid cooling, G = air cooling

H = protective shield; no letter=no protective shield

## 2. INSTALLATION

### 2.1. TRANSPORT AND LIFTING OF THE MACHINE

On the power source bottom there are four fixed lifting points for lifting devices, hole diameter 47 mm. On the power source's front panel and above the wire feeder unit there are handles designed for moving the units on the floor.

Lift the entire power source only from lifting points on the bottom! You may move the units from handles only by hands, it is forbidden to use any mechanical devices!

Ensure that the unit is kept during lifting between lifting linens. When necessary use additional binding round the lifting linens and the unit's upper part. Use the protection between the lifting device and the unit in order to eliminate impacts and shocks.

### 2.2. SITING THE MACHINE

Site the machine on a stationary, horizontal, dry and clean base from which there does not come any dust etc. into inlet air through the rear grate.

**Ensure the free circulation of the cooling air.**

Degree of protection IP23C of the machine allows at its maximum the water jet coming in 60° angle to hit machine's outer covering. See to that the machine is positioned away from the line of the particle spray, created by grinding tools etc.

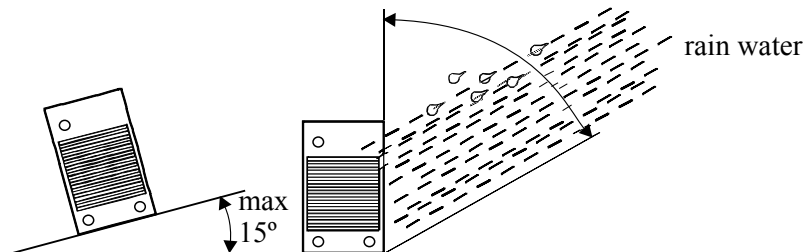

- See to that in front of the machine as well as at the rear of the machine there is at least 20 cm free distance to allow good circulation of the cooling air through the machine.
- Protect the machine against heavy rain and in circumstances over 25°C against direct sunshine

### 2.3. CONNECTION TO THE MAINS SUPPLY

**Connection and change of the mains cable and the plug must be carried out only by a competent electrician. Remove for the mounting of the mains cable the left side plate, seen from the front of the power source.**

The Kempoweld power source is equipped with 5 m supply cable without plug. The mains cable is according to the marking H07RN-F of the norm Cenelec HD22. The mains cable must be changed if it does not meet local regulations.

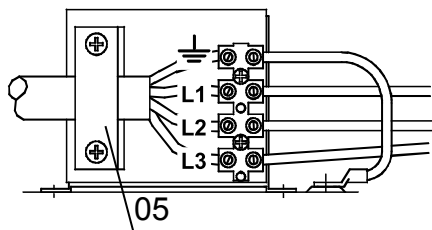

#### Mounting of the mains cable

The cable is entered into the machine through the inlet ring on the rear wall of the machine and locked with a cable clamp (05).

The phase conductors of the cable are coupled to connectors L1, L2 and L3. The earth protection coloured green-yellow is coupled to connector marked with earth protection symbol  $\oplus$ . If you are using 5-conductor cable, you must cut the zero conductor to the level of the cable's protective shield.

Sizes of mains cables and fuse ratings for the machine at 100% ED duty cycle are specified in the table below:

Kempoweld Rated voltage	4200		4200W		5500W
	230 V	400 V	230 V	400 V	400 V
Voltage range	220...240 V	380...415 V	220 V...240 V	380 V...415 V	380...415 V
Fuses, delayed	25 A	16 A	25 A	16 A	32 A
Connection cable	4 x 6.0 S mm <sup>2</sup>	4 x 2.5 S mm <sup>2</sup>	4 x 6.0 S mm <sup>2</sup>	4 x 2.5 S mm <sup>2</sup>	4 x 6.0 S mm <sup>2</sup>

In cables of S type there is protective grounding conductor coloured green-yellow.

### 2.4. WELDING AND RETURN CURRENT CABLES

Use only copper cables with cross-sectional area of at least 50 mm<sup>2</sup>. In enclosed table are shown typical loading capacities of rubber insulated copper cables, when ambient temperature is 25 °C and conductor temperature is 85 °C.



cable cross-section Cu	duty cycle ED			voltage loss / 10 m for 100 A
	100 %	60 %	40 %	
50 mm <sup>2</sup>	285 A	370 A	450 A	0.35 V
70 mm <sup>2</sup>	355 A	460 A	560 A	0.25 V
95 mm <sup>2</sup>	430 A	560 A	680 A	0.18 V

**⚠** Fasten the earthing press of the return current cable carefully, preferably direct onto the piece to be welded. The contact surface area of the press should always be as large and steady as possible. Do not overload welding cables over permissible values due to voltage losses and heating. Clean the contact surface from paint and rust.

## 2.5. OPERATION AND USE OF CONTROLS

See the page for Kempoweld panels. See the section for the Cooling unit.

### 2.5.1. Main switch (S1)

In zero position all control and welding current circuits of the equipment are dead (without voltage). In positions 15-28 V or 18-32 V and 28-48 V or 32-56 V the control circuits of the machine and the cooling unit become live (get voltage). The primary and welding circuit are dead, if the welding mode has not been started with the gun trigger.

**Always switch on and switch off the machine from the main switch. Never use the mains plug for switching on or switching off the units and equipment!**

### 2.5.2. Adjustment of welding voltage

With the main switch either the lower position (15-28 V or 18-32 V) or the higher position (28-48 V or 32-56 V) of welding voltage range is selected according to each welding case. The welding voltage is adjusted with two turn switches. The S2 is the switch for coarse control, where voltage value of each step can be fine-adjusted with the switch S3.

**Table of adjustments, switch positions:**

main switch voltage range	coarse control	fine control	4200, 4200W open circuit voltage	5500W open circuit voltage
lower	1 / 4	1- max	14.6 - 16.3 V	18.0 - 20.0 V
	2 / 4	1- max	16.6 - 18.8 V	20.7 - 23.0 V
	3 / 4	1- max	19.2 - 22.0 V	23.8 - 26.8 V
	4 / 4	1- max	22.5 - 26.1 V	27.9 - 32.0 V
higher	1 / 4	1- max	27.1 - 30.0 V	31.1 - 33.1 V
	2 / 4	1- max	30.5 - 34.2 V	36.4 - 40.3 V
	3 / 4	1- max	34.9 - 39.7 V	41.8 - 46.9 V
	4 / 4	1- max	40.5 - 47.1 V	49.0 - 56.2 V

### 2.5.3. Pilot lamps

Pilot lamps of the machine report about electric function:

The green pilot lamp H1 indicating that the machine is ready for operation is always lit, when the machine is connected to mains voltage and you have selected welding voltage range from the main switch.

The yellow pilot lamp H2 is lit, when thermal protection of the welding circuit has released due to overheating. The protection releases if the power source is continuously loaded over rated values or the cooling air circulation has been obstructed.

The cooling fan is cooling down the machine and after the pilot lamp has switched off, the machine is again ready for welding from the gun trigger.

### 2.5.4. Control fuse (F1)

On the rear plate of the power source the fuse (F1) 8 A delayed is the short-circuit protection. Use the fuse size and type according to markings. Damage caused by a wrong type fuse is not covered by the guarantee. If the fuse is blowing again, send the unit to service.

### 2.5.5. Adjustment for arc roughness



Arc roughness is adjusted by connecting the return current cable to the applicable one of the two dix-connectors on the front plate.

The connector marked with shorter symbol gives a rougher arc, which is used for welding of thin sheets and ferrous metals by 0.6 - 1.0 mm wires and especially with CO<sub>2</sub> shielding gas. The connector marked with longer symbol is suitable for thicker wires and especially for aluminium and stainless materials. The most suitable roughness is, however, most dependent on the welding case. You will find the best position by testing the different positions.

### 2.5.6. Operation of cooling fan

The cooling fan on the rear plate of the Kempoweld equipment is started and stopped according to use. The cooling fan is controlled by the gun trigger and control circuits. The cooling fan is started after ca. 15 s after weld start and stopped after ca. 10 min after weld end or release of the overheat protection.

Do not switch off the unit with the main switch before the cooling fan has automatically stopped. By open circuit the cooling fan does not get started.

### 2.5.7. Accessory drawer

In the accessory drawer of the power source are included the parts, needed in welding of aluminium and stainless materials and the parts for changing also the max. wire feed speed. In the drawer are also the screw and the insulation bushings needed for locking of rotation of the wire feeder.

### 2.5.8. Adjustment for wire feed

The wire feed is adjusted from the potentiometer on the control panel of the wire feeder unit. The adjustment has been described in the operation instructions of the wire feeder unit.

## 2.6. VOLT / AMPERE METERING UNIT MSD-1

Included in the delivery of Kempoweld 5500W. Accessory for Kempoweld 4200 and 4200W.

For the mounting of the MSD-1 remove the cover plate on the front panel of the unit. The connector of flat cable fastened to the cover plate is connected to the corresponding connector of the MSD-1. From the metering unit you can with lever switch select momentary display for either voltage or current. By open circuit only voltage value is displayed, because there is no welding current present.



The voltage value is the voltage between the unit's welding connectors or terminal voltage. The value of the open circuit voltage has not very much importance for the welding, so that the display of the metering unit is adjusted according to the welding situation. The display of the open circuit voltage differs 2-3 V from the true voltage. During welding the terminal voltage is varying and the arc voltage differs from the terminal voltage due to cable etc. losses. Accuracy of voltage true value in respect to real value is  $\pm 4,0\%$ ,  $\pm 0,2\text{ V}$  by welding values according to the norm. Accuracy of current true value in respect to real value is  $\pm 2,5\%$ ,  $\pm 2\text{ A}$ . The metering unit does not show wire feed values.

The MSD-1 does not need any calibration in the Kempoweld power source.

The switch positions: V = voltage display, A = current display.

## 2.7. COOLING UNIT

The Kempoweld 4200W and 5500W units have an inbuilt cooling unit inside the power source.

### 2.7.1. Installation of cooling

The cooling unit is connected to the gun by means of water hoses, which are mounted to the wire feeder unit. The interconnection cable contains also the water hoses, which are mounted to the gun through the wire feeder unit without any extension parts. See operation instruction for Kempoweld WIRE feeders.

Before connection check that in the hoses are no dirt, metal powder, rubber waste etc. The connectors for hoses and cooling unit are marked with red or blue identification rings or spots. Blue is colour for water supplied from cooling unit to gun and red is colour for water returning back from gun to cooling unit.

The cooling unit's tank is filled with 40 % antifreeze according to British Standard BS3151. If the circumstances do not require frost resistance, you can use a more dilute mixture, or some other mixture, of which you have good experiences.

Tank volume is ca. 3 litres, volume of gun and interconnection cable is 0.3-1.5 litres. Filling of hoses takes 5 s-3 min time. Check the return flow to the tank. Before filling check that tank, cooling water, pouring tank etc. are clean, and that there is no metal powder, waste etc.



**If the water does not start circulating, see paragraph Operation disturbances: "The water does not circulate... etc.**

**Do not let any waste and dirt into the water circulation! Check filling volume before starting to weld!**

**Use the cooling liquid according to recommendations, or the one you know as good beforehand. Watch over liquid material's quality and possible sediments in hoses of the gun.**

**Do not swallow cooling liquid. If somebody has swallowed the liquid, take him immediately to medical care. Avoid contact with skin and eyes, wash the liquid from your skin with clean water.**

## 2.7.2. Operation switches

In zero (O) position of the power source's main switch also all operations of the cooling unit are stopped.

### Cooling unit's main switch O / I

The electric supply for the pump motor is switched on by main switch key **O / I**, where the pilot lamp indicates the standby state **I**. In zero (**O**) position of the main switch the pump motor cannot get started, but the switches and pilot lamps are operating.

### Fuse (F2)

The fuse on the front wall of the cooling unit is short-circuit protection. Use the fuse size and type according to markings. If the fuse is blowing again, send the unit to service.

### Selecting switch for gun's cooling mode (Sw1)

The Kempoweld equipment are suitable to be used with both air- and water-cooled guns. Select cooling mode and correct use and protection functions with switch on the cooling unit's panel.

If your choice is **GAS**, but you are using water-cooled gun, no protection is operating. The pilot lamp is illuminated in position **I** of the cooling unit's main switch. However, the control does not start the pump.

### The wrong choice will destroy the gun in short time!

If your choice is  (water), but you are using air-cooled gun, the pump gets started by pressing on the trigger, if the cooling unit's main switch is in position **I**.

### Test switch (Sw5)

By **TEST** switch on the panel of the cooling unit you can circulate water without starting welding. It is used for filling the gun and interconnection cable with cooling water before starting welding. By disturbance situations you can always test the water circulation. Always check entry of return water into the tank before welding!

## Pilot lamps

### Pilot lamp for overheating (Hw4)

If the cooling water in the tank is overheating, the thermal protection will stop the power source. Operation of the cooling unit is continued for ca. 5 - 7 min automatically. The pilot lamp will switch off after the water in the tank has cooled down, after which the welding will start from the gun triggering.

### Pilot lamp for lacking liquid pressure (Hw3)

If the pump does not step up sufficient supply pressure, e.g. when the water is running out or by disturbances in the pump, the whole equipment will stop after ca. 5 s and the red pilot lamp illuminates. Check the equipment like by the installation. See paragraph for Operation disturbances.

## Operating control

The water circulation gets automatically started, when you are pressing on the gun trigger. The post-circulation of water will continue for ca. 5-7 min. after the weld end. The time is always counted from the latest trigger release.

# 3. OPERATION DISTURBANCES

**By the operation or functional disturbances take the measures according to the following list.**

**If the disturbance cannot be eliminated, check the equipment according to the paragraphs Installation and Maintenance, and take contact with Authorized Kemppi repair shop.**

### The pump does not get started by test switch:

- check the fuse on the front plate of the cooling unit
- check the fuse on the rear plate of the power source
- check position for cooling mode selecting switch
- check positions for main switches

### The water does not circulate by lever switch:

- check the tank filling volume
- disconnect the connector for the return water hose of the gun from the rear wall of the cooling unit and use the test switch

If the water is pumped, close the connector and run again by the test switch

A good tip: Blow compressed air into the tank; closing the filling opening by hand is enough.

**The water is pumping, but does not return back to the tank or the return flow is weak:**

- filling of interconnection cable can take several minutes
- if you have lifted the gun or interconnection cable for the filling time many meters higher than the power source, the filling will happen considerably slower. Fill the hoses on the floor position.
- check the whole flowing line connector by connector

**The water is pumping, but during welding the red pilot lamp for the water pressure is illuminated and the equipment is stopped:**

- check the cooling water volume and return flow to the tank
- in the system are air bubbles or leakages, especially check the connections of the cooling unit.
- the pressure switch set value (ca. 1 bar) is unsuitable for the gun you are using:
  1. Open the side plate. In the middle at the upper end of the pressure guard connected to the pump is the adjusting screw for limit value.
  2. Use the pump during the adjustment by the test switch.
  3. After ca. 5 s use twist the screw carefully until the pilot lamp is switched off.
  4. Check the result by welding.
  5. If the adjustment and checkings do not eliminate the disturbance, take contact with the Authorized Kemppi repair shop.

**During welding the yellow pilot lamp for overheating is lit and the equipment is stopped:**

- release the trigger. When the lamp is switched off, the operation has been reset automatically
- check if the gun is suitable for power you are using
- check condition of connectors and connections in the welding current circuit

## 4. MAINTENANCE

The amount of use and the working environment should be taken into consideration when planning the frequency of maintenance of the machine. Careful use and preventive maintenance will help to ensure trouble-free operation.

### Cables

Check the condition of welding and connection cables daily. Do not use faulty cables! Make sure that the mains connection cables in use are safe and according to regulations! The repair and mounting of mains connection cables should be carried out only by an authorized electrician.

### Power source

**NOTE!** Disconnect the plug of the power source from the mains socket before removing the cover plate.

**Check at least every 6 months (twice a year):**

- Electric connections of the unit - clean the oxidized parts and tighten the loosened ones. **NOTE!** You must know correct tension torques before starting the repair of the joints.
- Clean the inner parts of the machine from dust and dirt e.g. with soft brush and vacuum cleaner.

Do not use compressed air, there is a risk that dirt is packed even more tightly into gaps of components!

Do not use pressure washing device!

**Only authorized electrician shall carry out repairs to the machines.**

### Regular maintenance

Kemppi service repair shops make regular maintenance according to agreement.

The major points in the maintenance procedure are listed as follows:

- Cleaning of the machine
- Checking and maintenance of the welding tools
- Checking of connectors, switches and potentiometers
- Checking of electric connections
- Metering units checking
- Checking of mains cable and plug
- Damaged parts or parts in bad connection are replaced by new ones
- Maintenance testing. Operation and performance values of the equipment are checked, and adjusted when necessary by means of test equipment.

## 4.1. DISPOSAL OF THE MACHINE



Do not dispose of electrical equipment together with normal waste!

In observance of European Directive 2002/96/EC on Waste Electrical and Electronic Equipment and its implementation in accordance with national law, electrical equipment that has reached the end of its life must be collected separately and returned to an environmentally compatible recycling facility. As the owner of the equipment, you should get information on approved collection systems from our local representative.

By applying this European Directive you will improve the environment and human health!

## 5. TECHNICAL DATA

<b>Kempoweld</b>		<b>4200</b>	<b>4200W</b>	<b>5500W</b>
Connection voltage	3 ~ 400 V	380 V -10%...415 V +6%		380 V -10%...415 V +6%
	3 ~ 230 V	220 V -10%...240 V +6%		---
Connection capacity 230 V / 400 V	40 % ED	18,5 kVA		---
	60 % ED	13,5 kVA		30 kVA
	100 % ED	9,0 kVA		20 kVA
Mains cable / fuse	220 - 240 V	4 x 6,0 mm <sup>2</sup> / 25 A delayed		---
	380 - 415 V	4 x 2,5 mm <sup>2</sup> / 16 A delayed		4 x 6,0 mm <sup>2</sup> / 32 A delayed
Connection to wire feeder unit		30 V / 250 VA		30 V / 250 VA
	Fuse delayed	8 A		8 A
Loading capacity (nominal values)	40 % ED	420 A / 37,5 V		---
	60 % ED	325 A / 31 V		550 A / 42 V
	100 % ED	265 A / 27 V		430 A / 36 V
Control range		40 - 420 A / 15 - 37,5 V		50 - 550 A / 18 - 42 V
The amount of voltage steps	3 ~ 400 V	56		32
	3 ~ 230 V	32		---
Open circuit voltage		15 - 48 V		18 - 56 V
Open circuit power		< 50 W		< 50 W
Efficiency		75 % (420 A / 37,5 V)		80 % (550 A / 42 V)
Power factor		0,95 (420 A / 37,5 V)		0,95 (550 A / 42 V)
Temperature class		H (180°C)		H (180 °C)
Operation temperature range		-20...+60°C		-20...+60°C
Storage temperature range		-40...+60°C		-40...+60°C
Degree of protection		IP 23C		IP 23C
Cooling unit power		---	230 V/250 VA	230 V/250 VA
Fuse delayed		---	2 A	4 A
External dimensions	length	990 mm	990 mm	1075 mm
	width	530 mm	530 mm	480 mm
	height	880 mm	1090 mm	1140 mm
Weight		126 kg	138 kg	194 kg

The products meet conformity requirements for CE marking.

## 6. ORDERING NUMBERS

### Units

Kempoweld 4200	230 V	6215422
Kempoweld 4200	400 V	6215424
Kempoweld 4200W	230 V	6216422
Kempoweld 4200W	400 V	6216424
Kempoweld 5500W	400 V	6216554

### Wire feeder units

Kempoweld WIRE 400	621740001
Kempoweld WIRE 550	621755001

### Accessories:

KMW sync 2	6219150
MSD-1	6185666
Hub for wire reel	4289880
Branche cable KMP/Kempoweld	3151360

### MIG guns

#### Air-cooled:

MMT 35	3 m	6253513MMT
MMT 35	4,5 m	6253514MMT
WS 35 (Al 1.2)	6 m	6253516A12
WS 35 (SS 1.0)	6 m	6253516S10
MMT 42	3 m	6254213MMT
MMT 42	4,5 m	6254214MMT
KMP 300	6 m	6257306
KMP 300	10 m	6257310

#### Liquid-cooled:

MT 51W	3 m	6255046
MT 51W	4,5 m	6255047
MMT 42W	3 m	6254203MMT
MMT 42W	4,5 m	6254204MMT
MMT 52W	3 m	6255203MMT
MMT 52W	4,5 m	6255204MMT
KMP 400W	6 m	6257406
KMP 400W	10 m	6257410
WS 42W (Al 1.2-1.6)	6 m	6254206A12
WS 42W (SS 1.0)	6 m	6254206S10
WS 42W (SS 1.2)	6 m	6254206S12
WS 42W (Al 1.2-1.6)	8 m	6254208A12
WS 42W (SS 1.0)	8 m	6254208S10
WS 42W (SS 1.2)	8 m	6254208S12

### Air-cooled interconnection cables

#### Mounting cables for short distance:

KW 50-1.3-K	6260350
-------------	---------

#### Interconnection cables for long distance:

Multimig 50-5-K	6260104
Multimig 50-10-K	6260106
Multimig 50-5-KH	626010401
Multimig 50-10-KH	626010601

### Liquid-cooled interconnection cables

#### Mounting cables for short distance:

KW 50-1.5-W	6260352
KW 95-1.5-W	6260391

#### Interconnection cables for long distance:

KW 50-5-W	6260354
KW 50-10-W	6260356
KW 50-5-WH	626035401
KW 50-10-WH	626035601
KW 70-5-WH	6260373
KW 70-10-WH	6260374
KW 95-5-WH	6260393
KW 95-10-WH	6260394

#### Return current cable

5 m - 50 mm <sup>2</sup>	6184511
5 m - 70 mm <sup>2</sup>	6184711
5 m - 95 mm <sup>2</sup>	6184921

---

## 7. TERMS OF GUARANTEE

Kemppi Oy provides a guarantee for products manufactured and sold by them if defects in manufacture and materials occur. Guarantee repairs must be carried out only by an Authorised Kemppi Service Agent. Packing, freight and insurance costs to be paid by orderer. The guarantee is effected on the date of purchase. Verbal promises which do not comply with the terms of guarantee are not binding on guarantor.

### ***Limitations on guarantee***

The following conditions are not covered under the terms of guarantee: defects due to natural wear and tear, non-compliance with operating and maintenance instructions, connection to incorrect or faulty supply voltage (including voltage surges outside equipment spec.), incorrect gas pressure, overloading, transport or storage damage, fire of damage due to natural causes i.e. lightning or flooding.

This guarantee does not cover direct or indirect travelling costs, daily allowances or accommodation. Note: Under the terms of guarantee, welding torches and their consumables, feeder drive rolls and feeder guide tubes are not covered. Direct or indirect damage due to a defective product is not covered under the guarantee. The guarantee is void if changes are made to the product without approval of the manufacturer, or if repairs are carried out using non-approved spare parts.

The guarantee is also void if repairs are carried out by non-authorized agents.

### ***Undertaking guarantee repairs***

Guarantee defects must be informed to Kemppi or authorised Kemppi Service Agents within the guarantee period. Before any guarantee work is undertaken, the customer must provide proof of guarantee or proof of purchase, and serial number of the equipment in order to validate the guarantee. The parts replaced under the terms of guarantee remain the property of Kemppi.

Following the guarantee repair, the guarantee of the machine or equipment, repaired or replaced, will be continued to the end of the original guarantee period.

KEMPPi OY  
PL 13  
FIN – 15801 LAHTI  
FINLAND  
Tel (03) 899 11  
Telefax (03) 899 428  
www.kemppi.com

KEMPPiKONEET OY  
PL 13  
FIN – 15801 LAHTI  
FINLAND  
Tel (03) 899 11  
Telefax (03) 7348 398  
e-mail: myynti.fi@kemppi.com

KEMPPi SVERIGE AB  
Box 717  
S – 194 27 UPPLANDS VÄSBY  
SVERIGE  
Tel (08) 59 078 300  
Telefax (08) 59 082 394  
e-mail: sales.se@kemppi.com

KEMPPi NORGE A/S  
Postboks 2151, Postterminalen  
N – 3103 TØNSBERG  
NORGE  
Tel 33 34 60 00  
Telefax 33 34 60 10  
e-mail: sales.no@kemppi.com

KEMPPi DANMARK A/S  
Literbuen 11  
DK – 2740 SKOVLUNDE  
DANMARK  
Tel 44 941 677  
Telefax 44 941 536  
e-mail:sales.dk@kemppi.com

KEMPPi BENELUX B.V.  
Postbus 5603  
NL – 4801 EA BREDA  
NEDERLAND  
Tel (076) 5717 750  
Telefax (076) 5716 345  
e-mail: sales.nl@kemppi.com

KEMPPi (UK) Ltd  
Martti Kemppi Building  
Fraser Road  
Priory Business Park  
BEDFORD, MK443WH  
ENGLAND  
Tel 0845 6444201  
Fax 0845 6444202  
e-mail: sales.uk@kemppi.com

KEMPPi FRANCE S.A.  
S.A. au capital de 5 000 000 F.  
65 Avenue de la Couronne des Prés  
78681 EPONE CEDEX  
FRANCE  
Tel (01) 30 90 04 40  
Telefax (01) 30 90 04 45  
e-mail: sales.fr@kemppi.com

KEMPPi GmbH  
Otto – Hahn – Straße 14  
D – 35510 BUTZBACH  
DEUTSCHLAND  
Tel (06033) 88 020  
Telefax (06033) 72 528  
e-mail:sales.de@kemppi.com

KEMPPi SP. z o.o.  
Ul. Piłsudskiego 2  
05-091 ZĄBKl  
Poland  
Tel +48 22 781 6162  
Telefax +48 22 781 6505  
e-mail: info.pl@kemppi.com

KEMPPi WELDING  
MACHINES AUSTRALIA PTY LTD  
P.O. Box 404 (2/58 Lancaster Street)  
Ingleburn NSW 2565, Australia  
Tel. +61-2-9605 9500  
Telefax +61-2-9605 5999  
e-mail: info@kemppi.com.au